



Model Number: XS-A



- ❑ New 2D massage mechanism with flower-shaped rollers
- ❑ SL track
- ❑ Negative oxygen ion
- ❑ Health check
- ❑ Airbag massage for whole body
- ❑ Heating function for back
- ❑ Massage rollers for foot
- ❑ Bluetooth speaker
- ❑ Zero gravity
- ❑ 5cm against the wall
- ❑ LED light

1. Turn on the power button on the remote controller to operate the massage chair
2. After press the power button, it will enter the auto mode programm. Choose the different auto mode from the remote controller.
3. To adjust the details as users' requirement (strength, air pressure, angles, time, bluetooth speaker etc)
4. Enjoy the massage

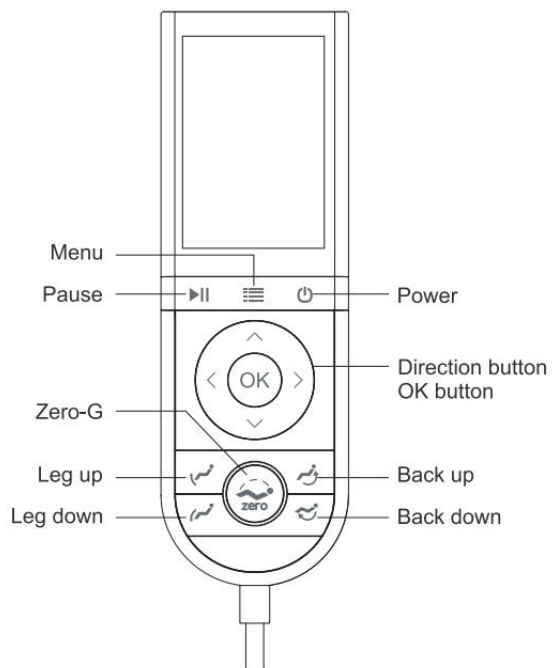
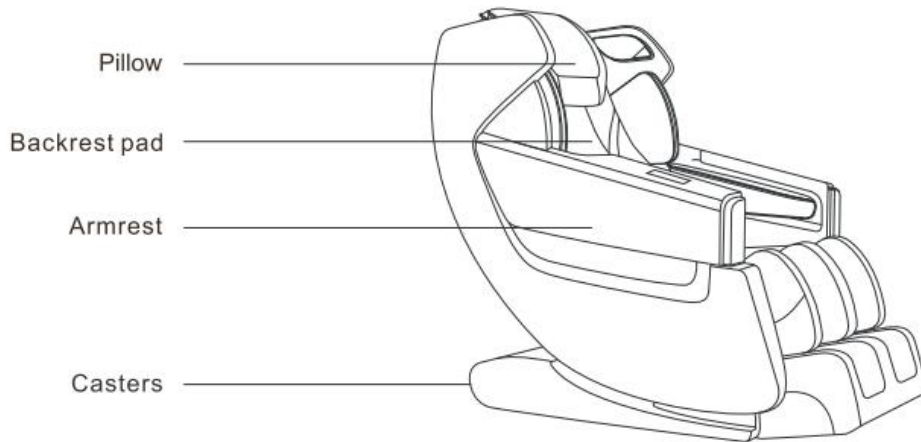
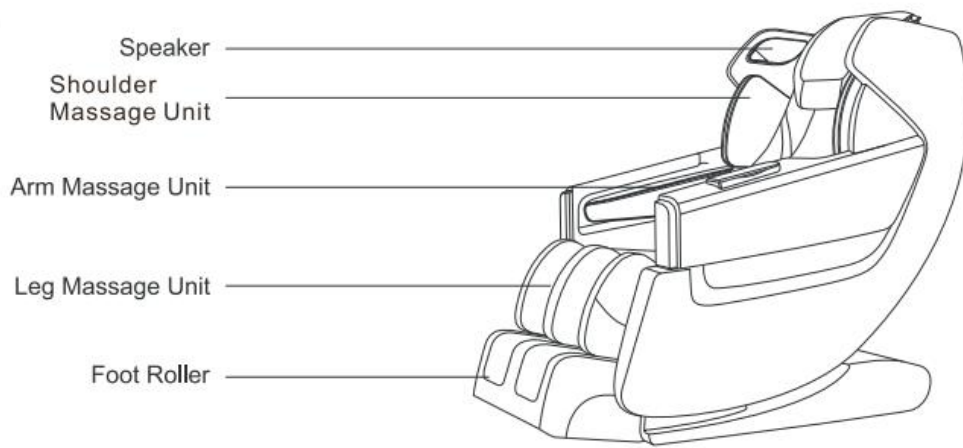

Functions of Controller

Power: 

When plugged on, press power button to start the massage chair and press again to shut off.

Pause: 

Press pause button to stop all massage function at the same time, and press stop button again to restart work again

Menu: 

Press menu button to check the function list.

Direction button and OK button:



Press up, down, left and right to choose corresponding functions and confirm with OK button to start it. In shoulder testing and auto mode, press up or down can control movement location of part and fixed point.

Zero-G: 

Press zero-g button to shut or shift gravity level

Back up: 

Long press this button to up backrest until an appropriate level and loose the press to lock the adjusted angle.

Back down: 

Long press this button to down backrest until an appropriate level and loose the press to lock the adjusted angle.

Leg up: 





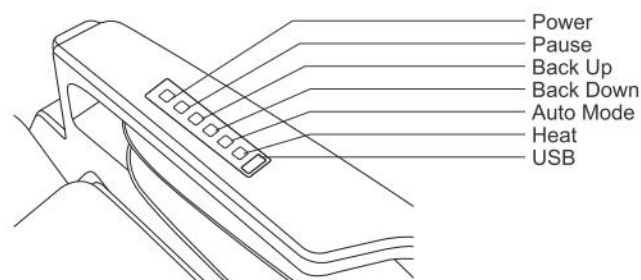

Long press this button to up leg until an appropriate level and loose the press to lock the adjusted angle.

Leg down: 

Long press this button to down leg until an appropriate level and loose the press to lock the adjusted angle.

Shortcut Buttons



Function	Button	Instruction
Power		Press this button to turn on / off.
Pause		Press this button to pause / start.
Back Up		Press this button to up backrest until an appropriate level and loose the press to lock the adjusted angle.
Back Down		Press this button to down backrest until an appropriate level and loose the press to lock the adjusted angle.
Auto Mode		Press this button to switch between multiple automatic modes. According to your physical condition, choose an automatic mode for targeted massage.
Heat		Press this button once to turn on the heating function, Press again to turn off the heating function.

Model Number	XS-A		
Type	Massage Chair	Time	10 min/20 min/30 min
Specification	Power	140W	Volt
			110-240V/50-60Hz
Carton size	1240*765*1160MM	N.W/G.W	75KGS/95KGS
Materials	Metal, Plastic,ABS,Synthetic Leather		

MARKING PLATE

